

TECHNICAL SHEET / SCHEDA TECNICA



Proccoppio

V9 Dry convective system



TEKNEITALIA[®]

The Art of Quality



GELATO



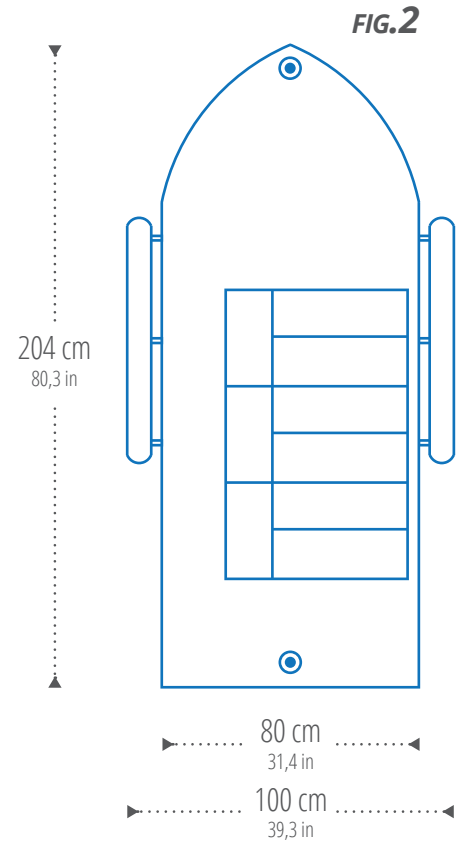
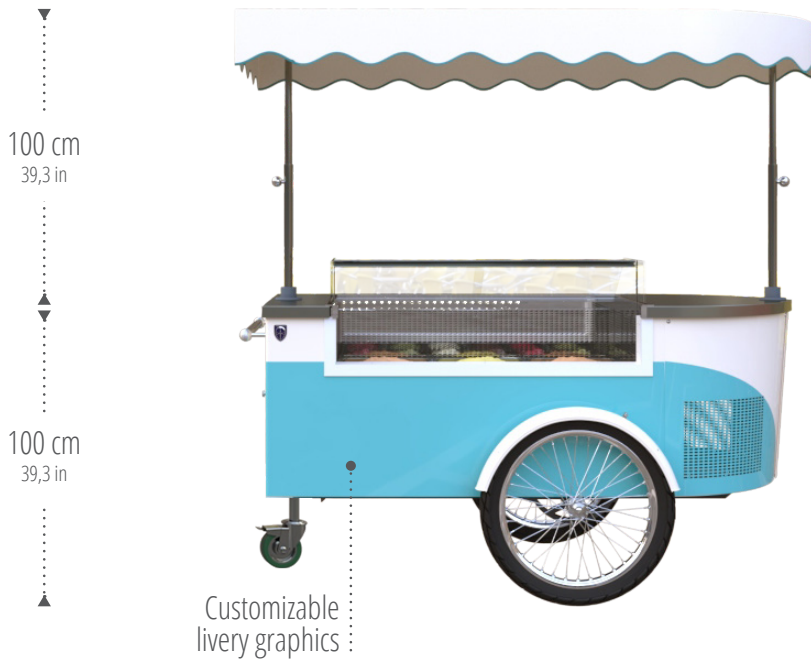

V9 Dry convective system

MEASURES/MISURE



TECHNICAL SPECIFICATIONS

CERTIFICATION

		
EMPTY WEIGHT KG	about 300	300 circa
LOAD CAPACITY	9+9 tanks (5kg each) total 90kg	9+9 vaschette (5kg cad.) totale 90kg
OPERATING COLD ROOM TEMPERATURE	-25°/+5°C, -13°/+41° F	-25°/+5°C
CLIMATE CLASS	from 0° to 35°C	da 0° a 35°C
COLD AUTONOMY	Need to be plugged	Necessita di esser collegato
STANDARD FEATURE/DOTAZIONI STANDARD		
BODY	Painted aluminium	Alluminio verniciato
OVERLAY	Telescopic and removable tent in stainless steel	Tenda telescopica e smontabile in acciaio INOX
LIGHTING	Removable LED light in stainless steel	Plafoniera smontabile LED in acciaio INOX
WORKTOP	Stainless Steel	Acciaio INOX
POWER SUPPLY	240V/50Hz or 110V/60Hz	240V/50Hz oppure 110V/60Hz
POWER CONSUMPTION	450W	450W

Subject to technical modifications

Mezzo soggetto a modifiche tecniche



Glycol system



Models

Cooling System



Injected polyurethane without HCFC/CFC
Glycol refrigeration
Condensing hermetic system with motor fan,
temperature control, copper evaporator
-25°/+5°C
from 0° to 35°C
6/7 hours



**PROCOPIO P6
PROCOPIO P8
PROCOPIO P3 SLIM
PROCOPIO P4 SLIM
PROCOPIO P4 XSLIM
PROCOPIO P3 XSLIM
DON COLA IN
DON COLA FX
DON GIOVANNI
GEA IN
ERMES**

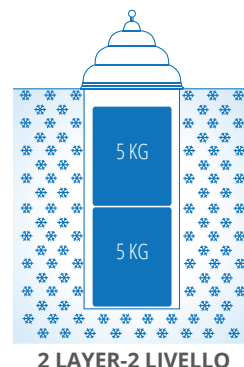

Poliuretano iniettato senza HCFC/CFC
Refrigerazione a Glicole
Sistema condensante ermetico con motoventilatore,
controllo della temperatura, evaporatore in rame
-25°/+5°C
da 0° a 35°C
6/7 ore



**KATERINA P6
KATERINA P8
KATERINA P4 SLIM
KATERINA P6 SLIM
DON COLA OUT
GEA OUT
ERMES**

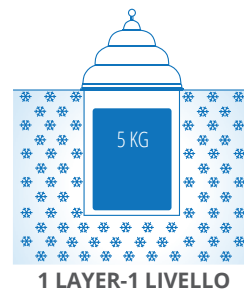

Dry convective system



Models



Injected polyurethane without HCFC/CFC
Dry refrigeration
Condensing hermetic system with motor fan,
temperature control, copper evaporator
-25°/+5°C
from 0° to 35°C
30 min



**PROCOPIO V6
PROCOPIO V9**

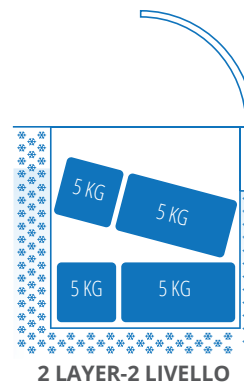

Poliuretano iniettato senza HCFC/CFC
Refrigerazione a secco
Sistema condensante ermetico con motoventilatore,
controllo della temperatura, evaporatore in rame
-25°/+5°C
da 0° a 35°C
30 min



**KATERINA V6
KATERINA V6 SLIM**

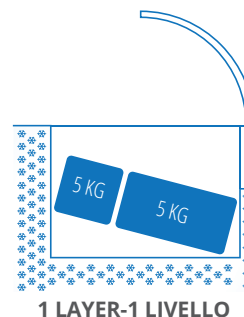

TECHNICAL SHEET / SCHEDA TECNICA



Procoppio

Detachable bike system



Katerina

Detachable bike system



TEKNĒITALIA[®]

The Art of Quality



GELATO

