

TECHNICAL SHEET / SCHEDA TECNICA



Proccopio

P3 SLIM Glycol system



TEKNEITALIA®

The Art of Quality



GELATO



P3 SLIM Glycol system

MEASURES/MISURE



FIG. 1

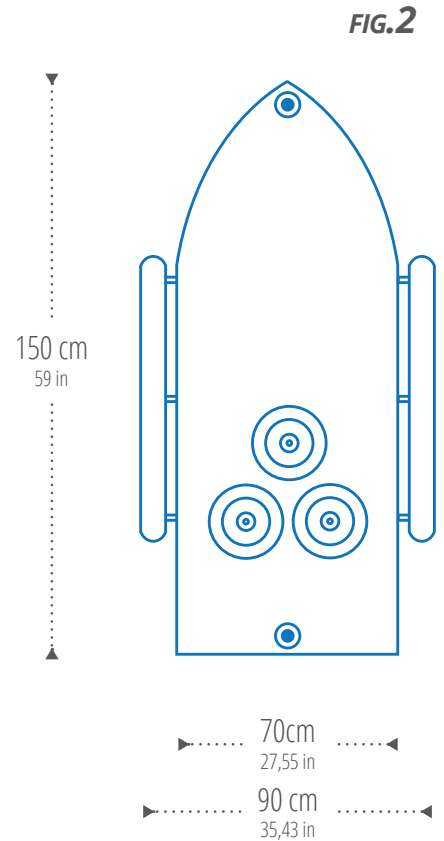



FIG. 2

TECHNICAL SPECIFICATIONS

CERTIFICATION

		
EMPTY WEIGHT KG	about 250	250 circa
LOAD CAPACITY	3+3 Stainless steel tubs (5kg each) total 30kg	3+3 carapine (5kg cad.) totale 30kg
OPERATING COLD ROOM TEMPERATURE	-25°/+5°C, -13°/+41° F	-25°/+5°C
CLIMATE CLASS	from 0° to 35°C	da 0° a 35°C
COLD AUTONOMY	6/7 hours	6/7 ore
STANDARD FEATURE/DOTAZIONI STANDARD		
BODY	Painted aluminium	Alluminio verniciato
OVERLAY	Telescopic and removable tent in stainless steel	Tenda telescopica e smontabile in acciaio INOX
LIGHTING	Removable LED light in stainless steel	Plafoniera smontabile LED in acciaio INOX
WORKTOP	Stainless steel	Acciaio INOX
POWER SUPPLY	240V/50Hz or 110V/60Hz	240V/50Hz oppure 110V/60Hz
POWER CONSUMPTION	450W	450W

Subject to technical modifications

Mezzo soggetto a modifiche tecniche



Glycol system



Models

Cooling System



Injected polyurethane without HCFC/CFC
Glycol refrigeration
Condensing hermetic system with motor fan,
temperature control, copper evaporator
-25°/+5°C
from 0° to 35°C
6/7 hours



PROCOPIO P6
PROCOPIO P8
PROCOPIO P3 SLIM
PROCOPIO P4 SLIM
PROCOPIO P4 XSLIM
PROCOPIO P3 XSLIM
DON COLA IN
DON COLA FX
DON GIOVANNI
GEA IN
ERMES

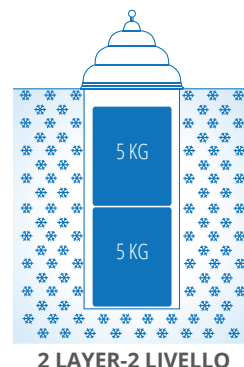

Poliuretano iniettato senza HCFC/CFC
Refrigerazione a Glicole
Sistema condensante ermetico con motoventilatore,
controllo della temperatura, evaporatore in rame
-25°/+5°C
da 0° a 35°C
6/7 ore

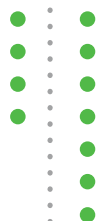

KATERINA P6
KATERINA P8
KATERINA P4 SLIM
KATERINA P6 SLIM
DON COLA OUT
GEA OUT
ERMES

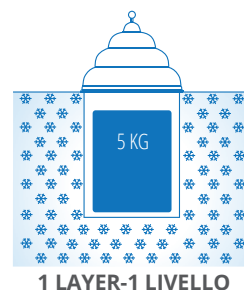

Dry convective system



Models



Injected polyurethane without HCFC/CFC
Dry refrigeration
Condensing hermetic system with motor fan,
temperature control, copper evaporator
-25°/+5°C
from 0° to 35°C
30 min



PROCOPIO V6
PROCOPIO V9

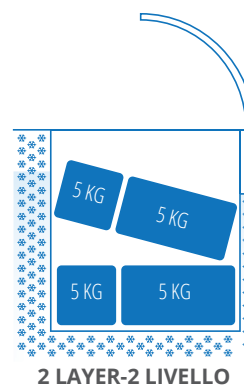

Poliuretano iniettato senza HCFC/CFC
Refrigerazione a secco
Sistema condensante ermetico con motoventilatore,
controllo della temperatura, evaporatore in rame
-25°/+5°C
da 0° a 35°C
30 min



KATERINA V6
KATERINA V6 SLIM

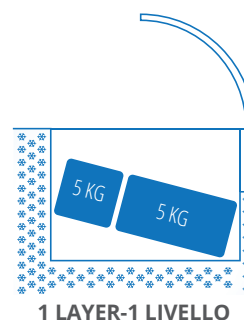

TECHNICAL SHEET / SCHEDA TECNICA



Procoppio

Detachable bike system



Katerina

Detachable bike system



TEKNĒITALIA[®]

The Art of Quality



GELATO



TECHNICAL SHEET / SCHEDA TECNICA



Proccopio

P4 SLIM Glycol system



TEKNEITALIA[®]

The Art of Quality



GELATO



MEASURES/MISURE

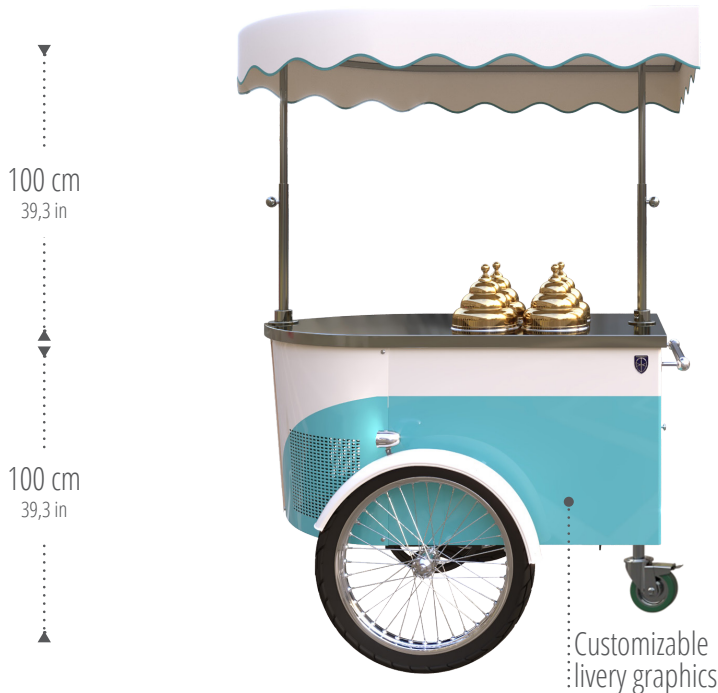

FIG. 1

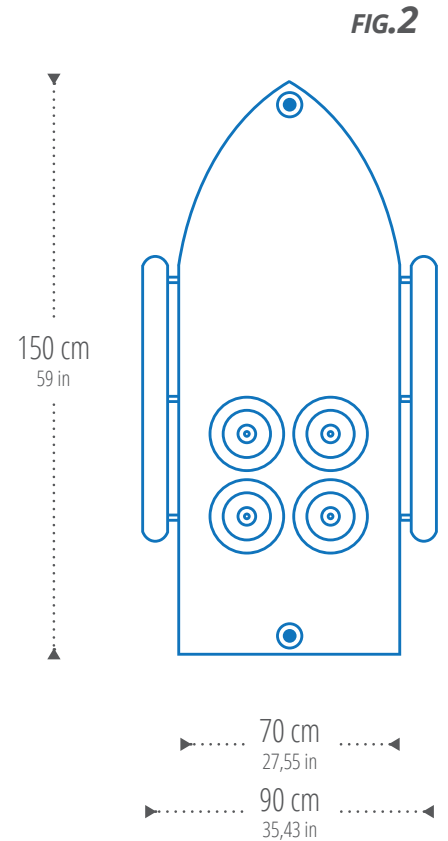



FIG. 2

TECHNICAL SPECIFICATIONS

CERTIFICATION

		
EMPTY WEIGHT KG	about 280	280 circa
LOAD CAPACITY	4+4 Stainless steel tubs (5kg each) total 40kg	4+4 carapine (5kg cad.) totale 40kg
OPERATING COLD ROOM TEMPERATURE	-25°/+5°C, -13°/+41° F	-25°/+5°C
CLIMATE CLASS	from 0° to 35°C	da 0° a 35°C
COLD AUTONOMY	6/7 hours	6/7 ore
STANDARD FEATURE/DOTAZIONI STANDARD		
BODY	Painted aluminium	Alluminio verniciato
OVERLAY	Telescopic and removable tent in stainless steel	Tenda telescopica e smontabile in acciaio INOX
LIGHTING	Removable LED light in stainless steel	Plafoniera smontabile LED in acciaio INOX
WORKTOP	Stainless Steel	Acciaio INOX
POWER SUPPLY	40V/50Hz or 110V/60Hz	240V/50Hz oppure 110V/60Hz
POWER CONSUMPTION	450W	450W

Subject to technical modifications

Mezzo soggetto a modifiche tecniche



Glycol system



Models

Cooling System



Injected polyurethane without HCFC/CFC
Glycol refrigeration
Condensing hermetic system with motor fan,
temperature control, copper evaporator
-25°/+5°C
from 0° to 35°C
6/7 hours



PROCOPIO P6
PROCOPIO P8
PROCOPIO P3 SLIM
PROCOPIO P4 SLIM
PROCOPIO P4 XSLIM
PROCOPIO P3 XSLIM
DON COLA IN
DON COLA FX
DON GIOVANNI
GEA IN
ERMES

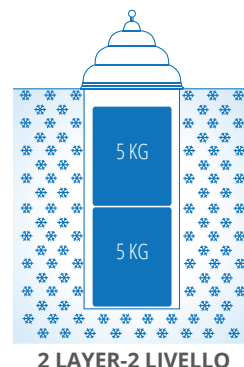

Poliuretano iniettato senza HCFC/CFC
Refrigerazione a Glicole
Sistema condensante ermetico con motoventilatore,
controllo della temperatura, evaporatore in rame
-25°/+5°C
da 0° a 35°C
6/7 ore



KATERINA P6
KATERINA P8
KATERINA P4 SLIM
KATERINA P6 SLIM
DON COLA OUT
GEA OUT
ERMES

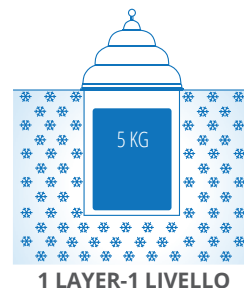

Dry convective system



Models



Injected polyurethane without HCFC/CFC
Dry refrigeration
Condensing hermetic system with motor fan,
temperature control, copper evaporator
-25°/+5°C
from 0° to 35°C
30 min



PROCOPIO V6
PROCOPIO V9

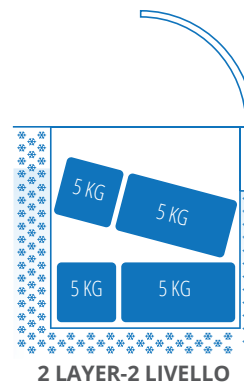

Poliuretano iniettato senza HCFC/CFC
Refrigerazione a secco
Sistema condensante ermetico con motoventilatore,
controllo della temperatura, evaporatore in rame
-25°/+5°C
da 0° a 35°C
30 min



KATERINA V6
KATERINA V6 SLIM

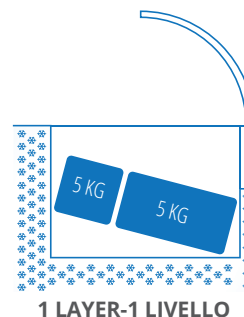

TECHNICAL SHEET / SCHEDA TECNICA



Procoppio

Detachable bike system



Katerina

Detachable bike system



TEKNĒITALIA[®]

The Art of Quality



GELATO

